

alumiplast

BOX – VIDRO TEMPERADO 6/8MM

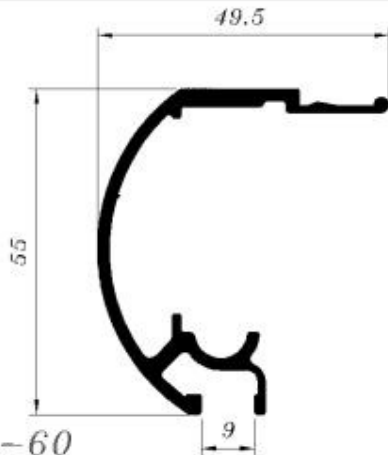

AL-60
0.863 kg/m

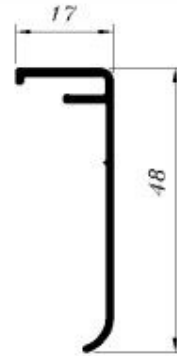

AL-59
0.215 kg/m

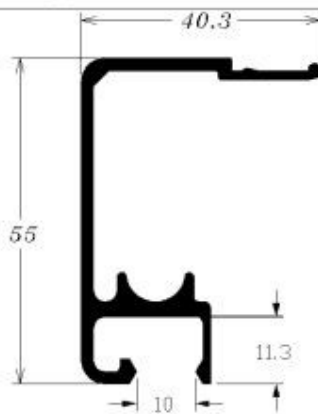

AL-49
0.790 kg/m



AL-50
0.250 kg/m

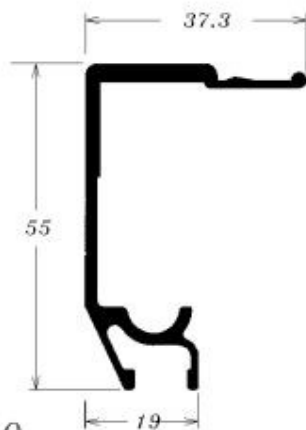

BX-050
0.646 kg/m

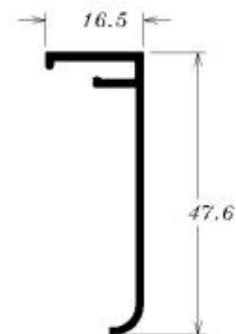

BX-051
0.213 kg/m



alumiplast

BOX – VIDRO TEMPERADO 6/8MM

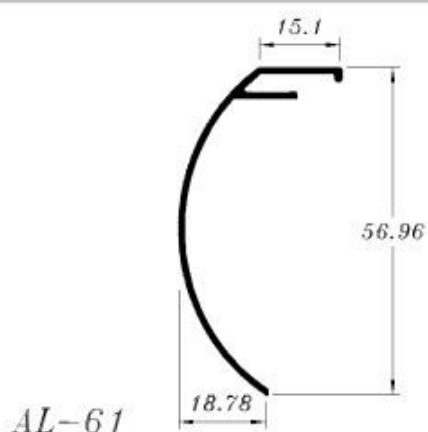

0.282 kg/m

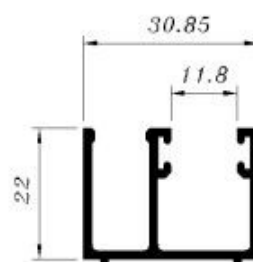

0.321 kg/m

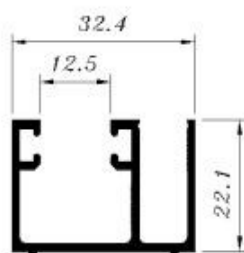

0.456 kg/m

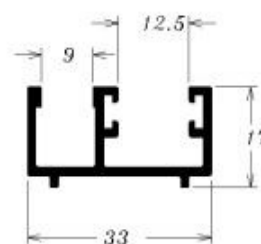

0.400 kg/m

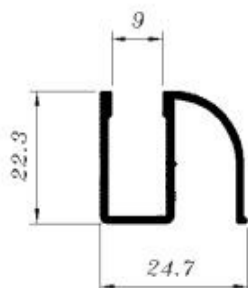

0.289 kg/m

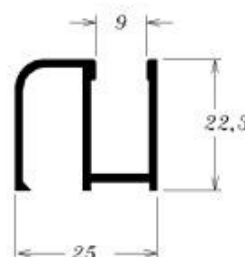

0.343 kg/m



alumiplast

BOX – VIDRO TEMPERADO 6/8MM

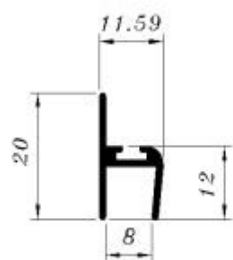

AL-63
0.168 kg/m

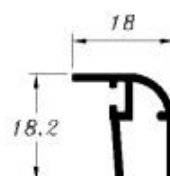

AL-64
0.158 kg/m

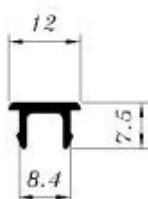

AL-65
0.099kg/m

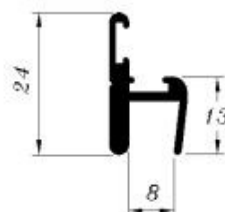

AL-47
0.272 kg/m

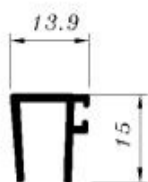

AL-46
0.153 kg/m

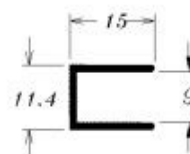

AL-44
0.132 kg/m



alumiplast

BOX – VIDRO TEMPERADO 6/8MM

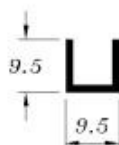

AL-28
0.108 kg/m

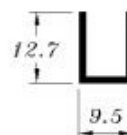

AL-29
0.129 kg/m

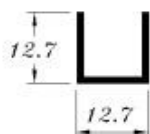

AL-30
0.151 kg/m



AL-66
0.160 kg/m